

DESCRIPTION

The RH108A is a precision operational amplifier particularly well-suited for high source impedance application-requiring low offset and bias currents and low power-consumption.

The wafer lots are processed to Linear Technology's in-house Class S flow to yield circuits usable in stringent-military applications.

For complete electrical specifications, performance curves and applications information, see the LM108A/LM108 data sheet.

ABSOLUTE MAXIMUM RATINGS

(Note 1)

Supply Voltage	±20V
Differential Input Current (Note 1)	±10mA
Input Voltage (Note 2).....	±15V
Output Short-Circuit Duration	Indefinite
Operating Temperature Range.....	-55°C to 125°C
Storage Temperature Range.....	-65°C to 150°C
Lead Temperature (Soldering, 10 sec)	300°C

LT, LT, LTC, LTM, Linear Technology and the Linear logo are registered trademarks of Linear Technology Corporation. All other trademarks are the property of their respective owners.

BURN-IN CIRCUIT

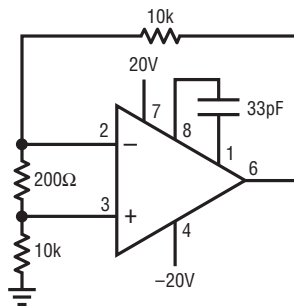

OR

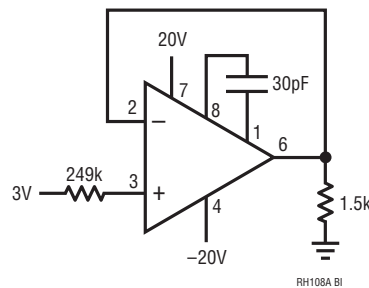

PACKAGE INFORMATION

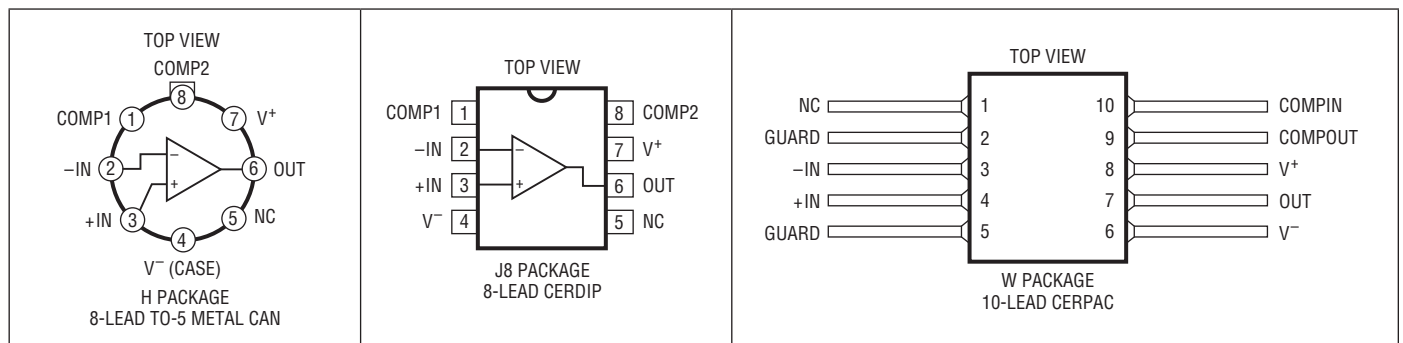

TABLE 1: ELECTRICAL CHARACTERISTICS (Preirradiation, Note 4)

SYMBOL	PARAMETER	CONDITIONS	NOTES	$T_A = 25^\circ\text{C}$			SUB-GROUP	$-55^\circ\text{C} \leq T_A \leq 125^\circ\text{C}$			SUB-GROUP	UNITS
				MIN	TYP	MAX		MIN	TYP	MAX		
V_{OS}	Input Offset Voltage					0.5	1			1.0	2,3	mV
$\frac{\Delta V_{OS}}{\Delta \text{Temp}}$	Average Tempco of Offset Voltage		3							5.0		$\mu\text{V}/^\circ\text{C}$
I_{OS}	Input Offset Current					0.2	1			0.4	2,3	nA
$\frac{\Delta I_S}{\Delta \text{Temp}}$	Average Tempco of Offset Current		3							2.5		$\text{pA}/^\circ\text{C}$
I_B	Input Bias Current					2.0	1			3.0	2,3	nA
A_{VOL}	Large-Signal Voltage Gain	$V_S = \pm 15\text{V}$, $V_{OUT} = \pm 10\text{V}$ $R_L \geq 10\text{k}$				80	4		40		5,6	V/mV
CMRR	Common Mode Rejection Ratio					96	1		96		2,3	dB
PSRR	Power Supply Rejection Ratio					96	1		96		2,3	dB
	Input Voltage Range	$V_S = \pm 15\text{V}$	3			± 13.5			± 13.5			V
V_{OUT}	Output Voltage Swing	$V_S = \pm 15\text{V}$, $R_L = 10\text{k}$				± 13	4		± 13		5,6	V
R_{IN}	Input Resistance		3			30						$\text{M}\Omega$
I_S	Supply Current	(Note 6)				0.6	1		0.4		2	mA

TABLE 1A: ELECTRICAL CHARACTERISTICS (Preirradiation, Note 4)

SYMBOL	PARAMETER	CONDITIONS	NOTES	10KRAD (Si)		20KRAD (Si)		50KRAD (Si)		80KRAD (Si)		UNITS	
				MIN	MAX	MIN	MAX	MIN	MAX	MIN	MAX		
V_{OS}	Input Offset Voltage					0.5		0.5			1.0	mV	
I_{OS}	Input Offset Current					0.3		0.3			0.3	nA	
I_B	Input Bias Current					± 2.0		± 2.0			± 4.0	nA	
A_{VOL}	Large-Signal Voltage Gain	$V_S = \pm 15\text{V}$, $V_{OUT} = \pm 10\text{V}$ $R_L \geq 10\text{k}$				98		98		90		86	dB
CMRR	Common Mode Rejection Ratio					96		96		84		70	dB
PSRR	Power Supply Rejection Ratio		4			96		96		84		70	dB
	Input Voltage Range		3			± 13.5		± 13.5		± 13.5		± 13.5	V
V_{OUT}	Output Voltage Swing					± 13		± 13		± 13		± 13	V
R_{IN}	Input Resistance		3			30		30		30		30	$\text{M}\Omega$
I_S	Supply Current					0.6		0.6		0.6		0.6	mA

Note 1: Stresses beyond those listed under Absolute Maximum Ratings may cause permanent damage to the device. Exposure to any Absolute Maximum Rating condition for extended periods may affect device reliability and lifetime.

Note 2: For supply voltages less than $\pm 15\text{V}$, the maximum input voltage is equal to the supply voltage.

Note 3: Guaranteed by design, characterization or correlation to othertested parameters.

Note 4: $\pm 5\text{V} \leq V_S \leq \pm 20\text{V}$ preirradiation, $\pm 5\text{V} \leq V_S \leq \pm 15\text{V}$ postirradiation, unless otherwise noted.

Note 5: $V_S = \pm 15\text{V}$, $V_{CM} = 0\text{V}$, $T_A = 25^\circ\text{C}$ unless otherwise noted.

Note 6: $25^\circ\text{C} \leq T_A \leq 125^\circ\text{C}$.

TABLE 2: ELECTRICAL TEST REQUIREMENTS

MIL-STD-883 TEST REQUIREMENTS	SUBGROUP
Final Electrical Test Requirements (Method 5004)	1*,2,3,4,5,6
Group A Test Requirements (Method 5005)	1,2,3,4,5,6
Group C and D End Point Electrical Parameters (Method 5005)	1

*PDA applies to subgroup 1. See PDA Test Notes.

PDA Test Notes

The PDA is specified as 5% based on failures from group A, subgroup 1, tests after cooldown as the final electrical test in accordance with method 5004 of MIL-STD-883 Class B. The verified failures (including Delta parameters) of group A, subgroup 1, after burn-in divided by the total number of devices submitted for burn-in in that lot shall be used to determine the percent for the lot.

Linear Technology Corporation reserves the right to test to tighter limits than those given.

TOTAL DOSE BIAS CIRCUIT

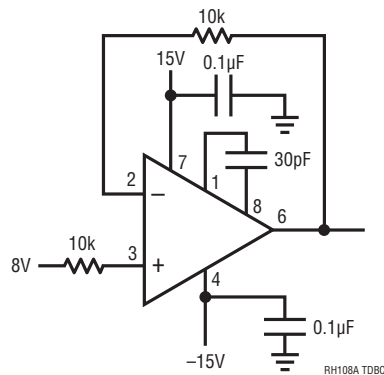

REVISION HISTORY (Revision history begins at Rev C)

REV	DATE	DESCRIPTION	PAGE NUMBER
C	11/10	Note 4 revised and added to Power Supply Rejection Ratio.	2

TYPICAL PERFORMANCE CHARACTERISTICS

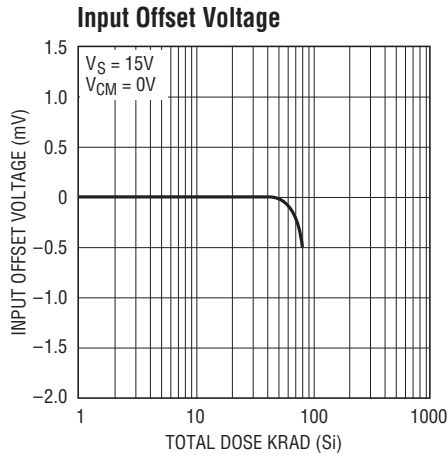

RH108A G01

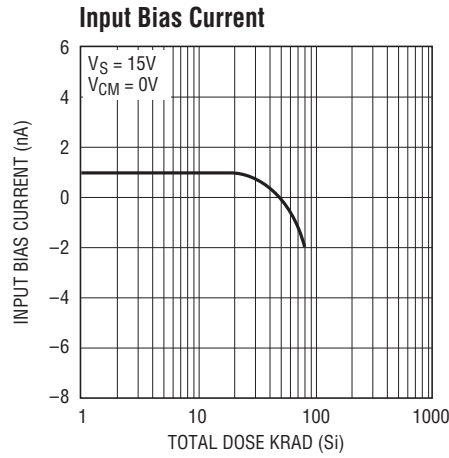

RH108A G02

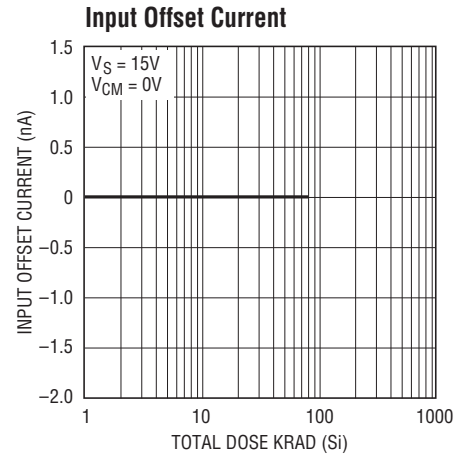

RH108A G03

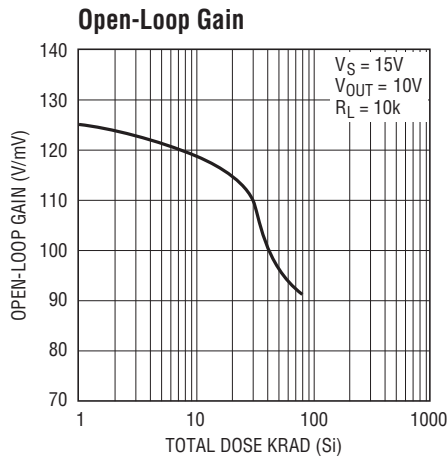

RH108A G04

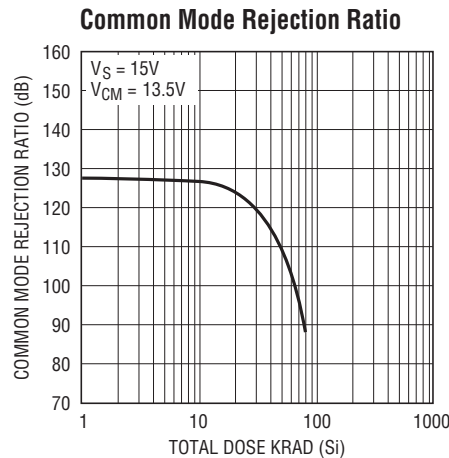

RH108A G05

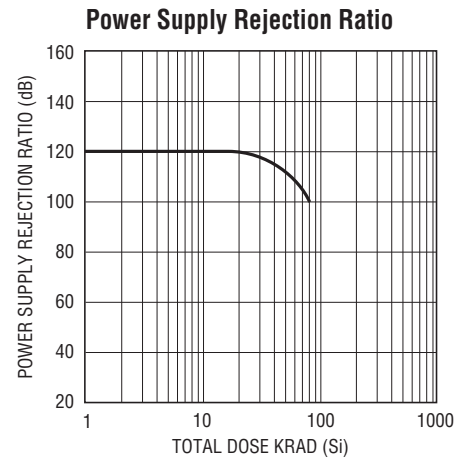

RH108A G06